

Introduction to ***Letex*** company & product
Technology Corp.

Profile



Since: 2001

Obtained ISO 9001:2015 Quality
Management System Certification

Passed UL certification and officially began
mass production

Passed CUL certification, RoHS compliant,
halogen-free

Letex Technology Corporation

NO.25,Sec.3,Xibin Road,Longjing Dist.,Taichung City,Taiwan

Tel. +886-4-2630-7366

Fax. +886-4-2630-7367

sales@letex.com.tw



Products

PHOTO MOS Relay

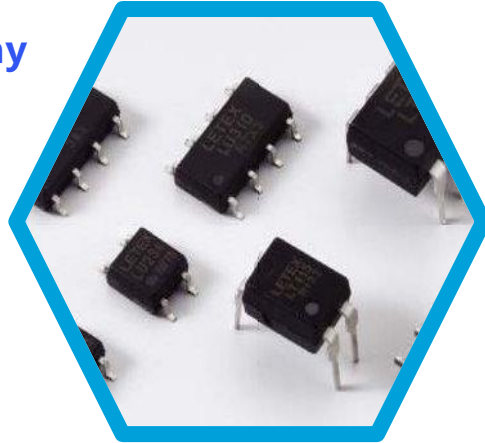
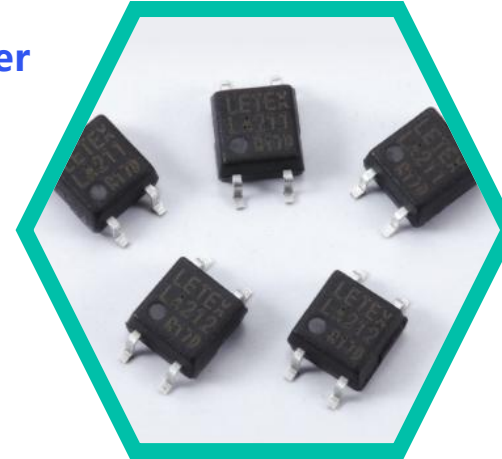

PHOTO Coupler



Photointerrupter



Magnetic Contact



Capacity

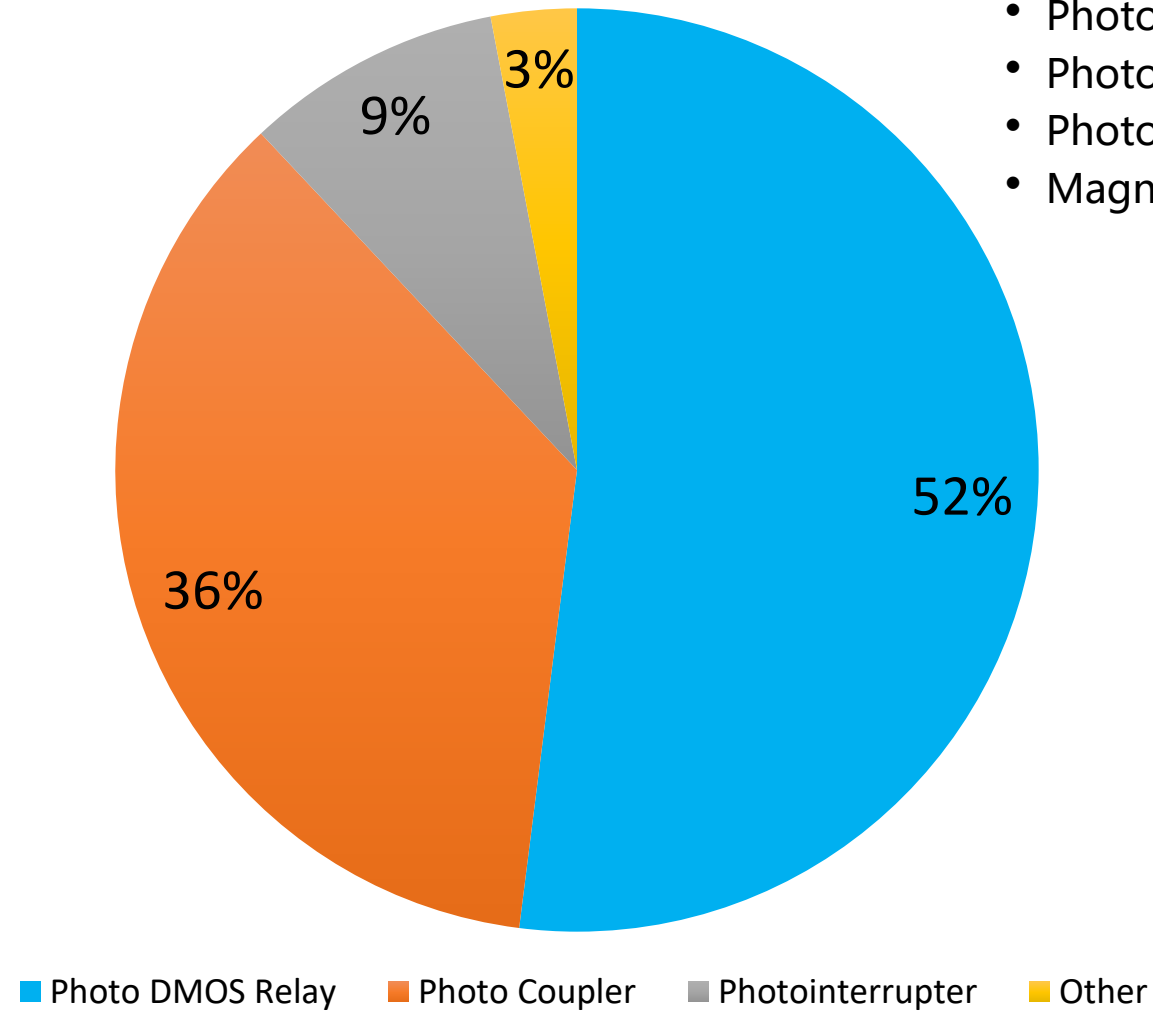

- Photo DMOS Relay : 6.6KK pcs / month
- Photo Coupler : 500K pcs/ month
- Photo Interrupter :300K pcs / month
- Magnetic :180K pcs / month

Photo DMOS Relay

光電繼電器

Photo MOS Relay can be used on both of AC and DC. It is a high reliable product with special features such limited permanency, low driver current, high isolation voltage, subminiature, light transmission, none mechanical contact....etc.

- I/O expansion card
- I/O mechanic control
- Access controller
- DAQ
- Remote I/O Module
- Infrared Detector (PIR)
- Camera
- Centrifuge

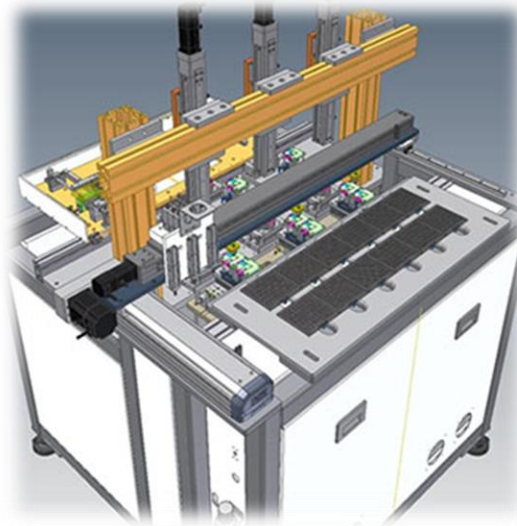
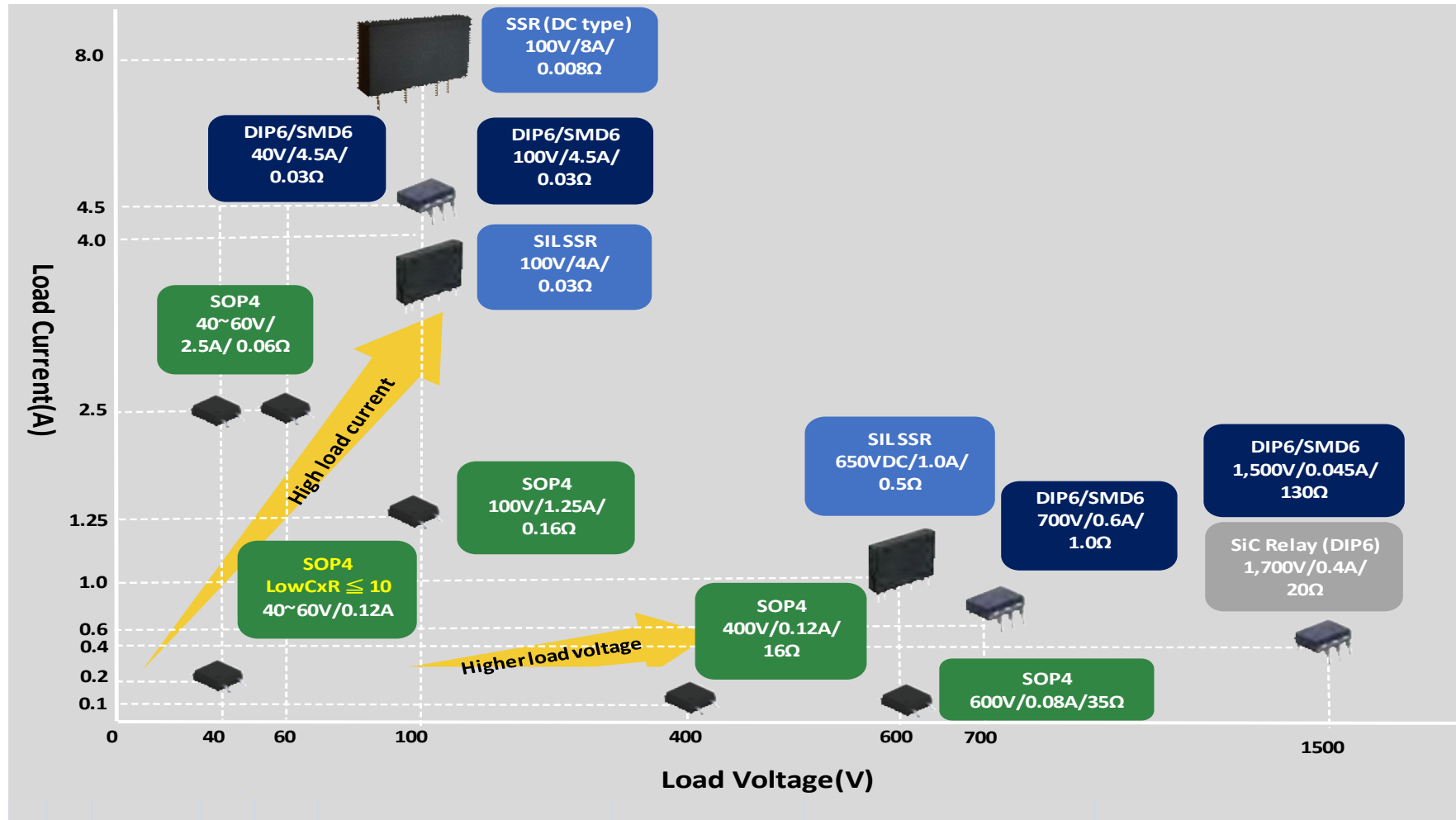

Photo Relay Road Map



Photocoupler 光藕合器

- The Photo Coupler is consisted of one couple of emission and receiving elements. It makes use of light to transmit signals, and then makes electrical insulation between input and output.

- Telephones/Fax machines
- Power switches / UPS
- Printers / Copy machines
- Household appliances
- Tunnel light
- I/O mechanical controller
- Elevator control
- Signal detector
- Card Reader



Photointerrupter 光遮斷器

- Copier
- Printer
- Home appliances
- Digital camera
- Coin machine
- CD-ROM drive
- Non-contact type switch
- Industrial position switch

- No-contact precision testing Device

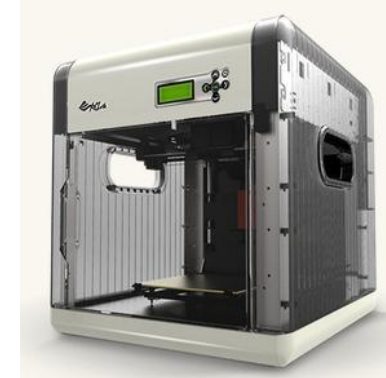

Magnetic Contact

磁簧開關

- To use a reed switch and magnet moving for interaction device.

- Industrial equipment
- Motor vehicles
- Large appliances
- Anti-theft doors and windows
- Machine safety devices
- Access control security equipment
- Lighting device
- Communications equipment industry



Overseas Market

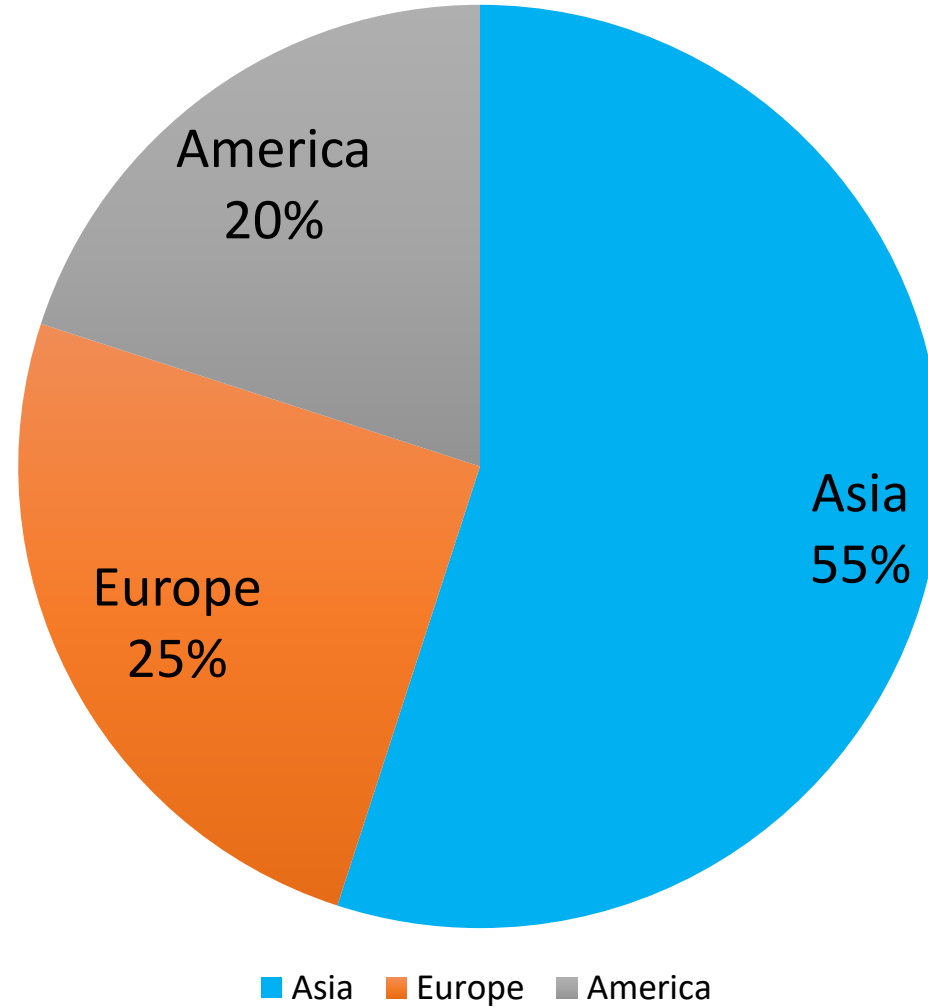

Products Roadmap

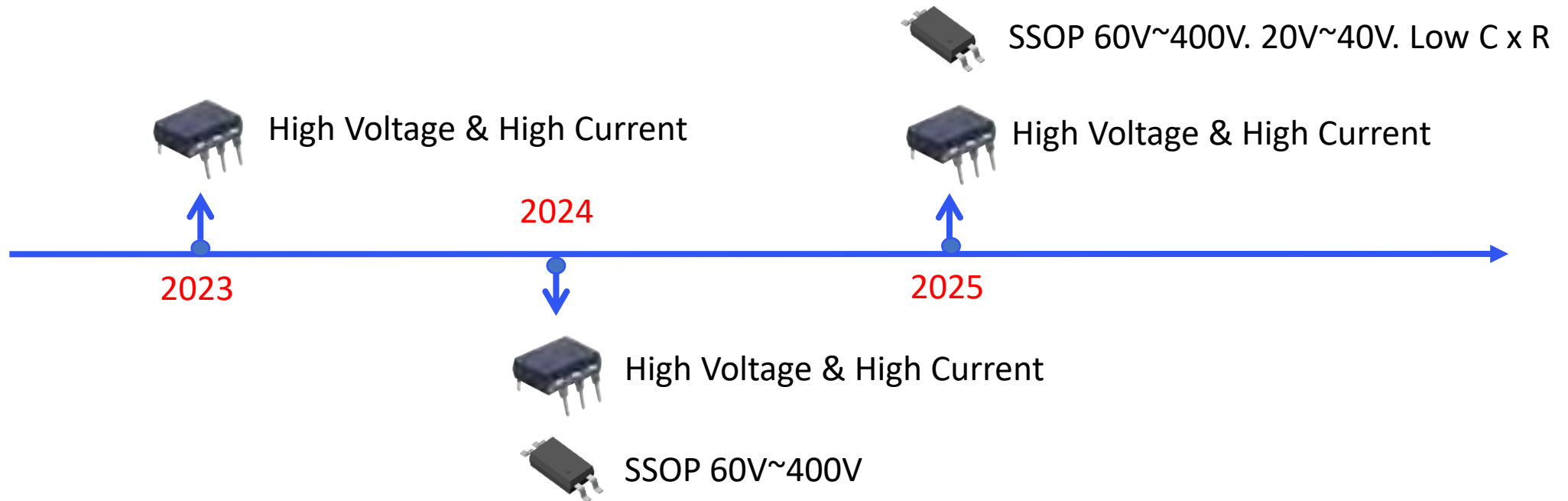

Photo MOS Relay application

1. 高壓規格(High Voltage)



2. 高耐流規格(High Current)



3. 通信信號規格(Communications Signal)



Customers and Partners

Letex
Technology Corp.

ADVANTECH

Dr.Storage

HIWIN
Motion Control and System Technology

OKITA

GEM

DEXATEK
Subsidiary of Ennoconn

NOVATEK

iBASE

GIANT

ADLINK

TASC

VIVOTEK

REALTEK

AUO

DELTA